



StairFurb
stairfurb.co.uk

Installation Manual
Using StairFurb Handrail
Version 6.0 JUNE 2018





ORDER OF ASSEMBLY

TOOLS YOU WILL NEED

- Fine Saw
- Sander
- Wood Filler
- Allen keys
- Screw Driver
- Drill
- Suitable Screws

PROTECTING THE COMPONENTS

Make sure all the glass panels are stored in a safe place until required. Protect all parts against scratches and knocks.

BEFORE COMMENCING WITH THE BUILD

Study the instructions fully so that you're familiar with all the parts of the assembly.

TWO PEOPLE RECOMMENDED

We recommend having a second person to help, as the glass panels can be heavy and will need to be supported whilst you secure them to the handrail and baserail. Also to support the handrail during fixing.

CLEANING

Only use recommended cleaning products on the surfaces.

NAMED PARTS TO A STAIRCASE

- Handrail
- Newel Post
- Spindles
- Baserail
- Closed Baserail

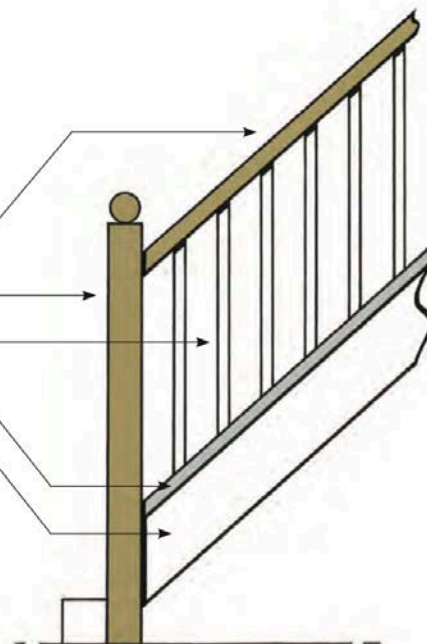

1. CUTTING OFF THE EXISTING SPINDLES OR TIMBER PANELS

There are possibly two ways of removing the spindles.

Using a fine saw cut through the top and bottom as diagram.

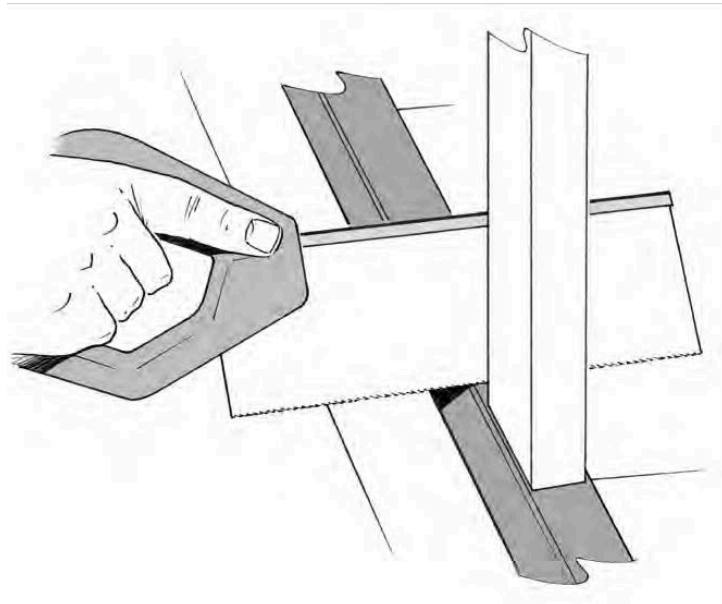

Or

If spindles are nailed or fitted into holes on the handrail and baserail, use a fine saw and cut at 45° through the spindle.

You should be able to wobble and twist (see diagram). Usually they will come away easily.

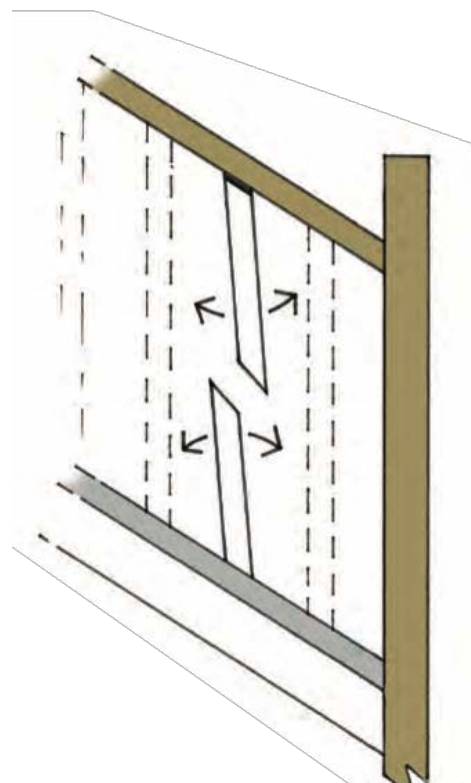
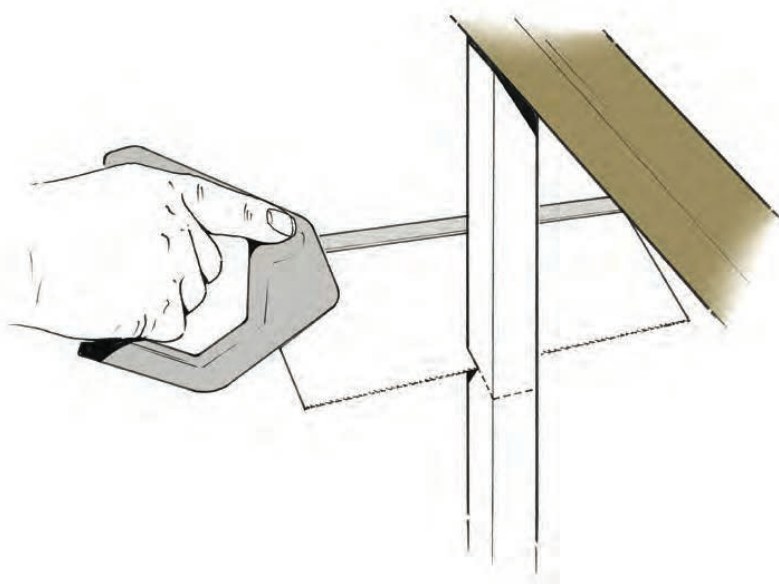

2. REPAIR EXISTING BASERAIL

To repair the baserail you can use wood filler and sand down or use StairFurb baserail, glue and pin as diagram. You can sand a rounded edge if required.

Undercoat and paint to finish.

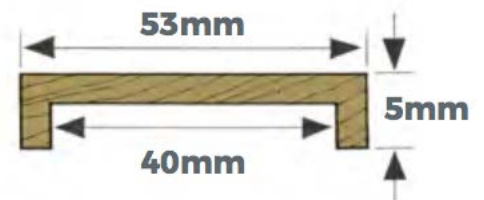
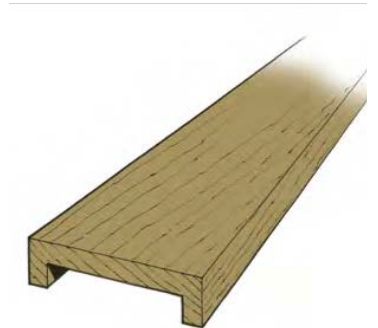
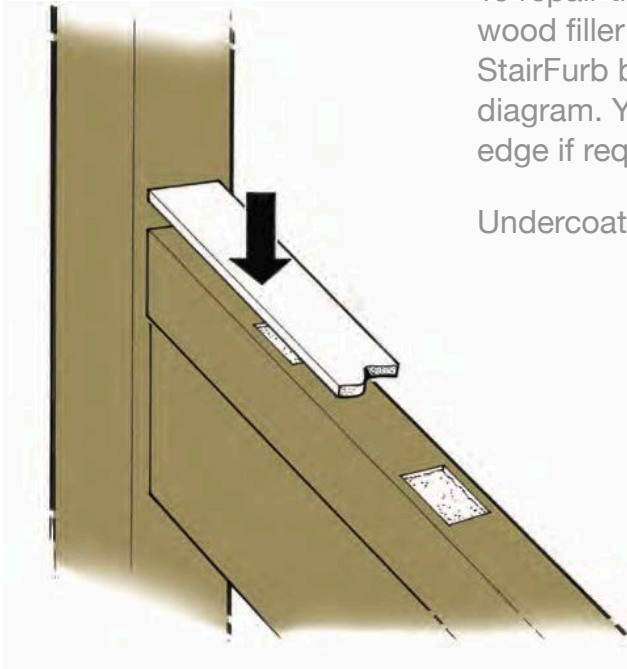

3. FITTING BOTTOM GLASS CLAMPS TO THE BASERAIL

Attached to the back of this guide (when supplied with delivered system) you will find a sheet which details the components for each of your ordered systems. On each is a diagram which illustrates the suggested location of each clamp. The measurements are to be taken from where the wall or new post meets the baserail. Measurements provided are for the centre of the clamp.



Customer Ref: FINN TN25

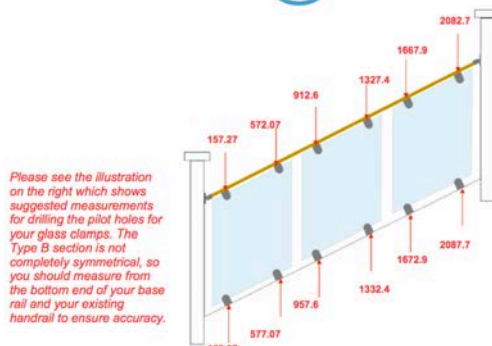

Measurements provided by customer:	Glass panel dimensions:	Number of glass panels:
A (height): 740		3
B (length): 2330		
Post Angle: 0		
Rail Angle: 48		
Number of clamps supplied:		
Flat back: 12		
Curved back: 0		

Fit the two 8mm rubbers one each side.
(See separate instruction sheet).

Drill pilot holes in the centre of the baserail
at each of these measurements and fit the
flat backed glass clamps as per the image

Fix using screws & washers supplied.

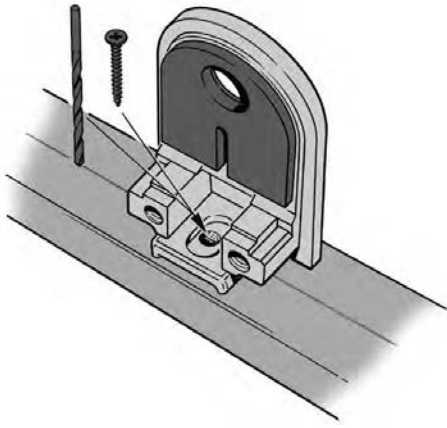

Fixing a string down the centre of the
baseball can aid in ensuring clamps are set
to the centre of the baserail

NOTE: clamp styles may vary

4. REMOVING THE HANDRAIL

(IF REPLACING WITH STAIRFURB HANDRAIL SYSTEM)

Saw off the handrail at both
ends as diagram, taking care to
hold the handrail securely.

Sand and finish.

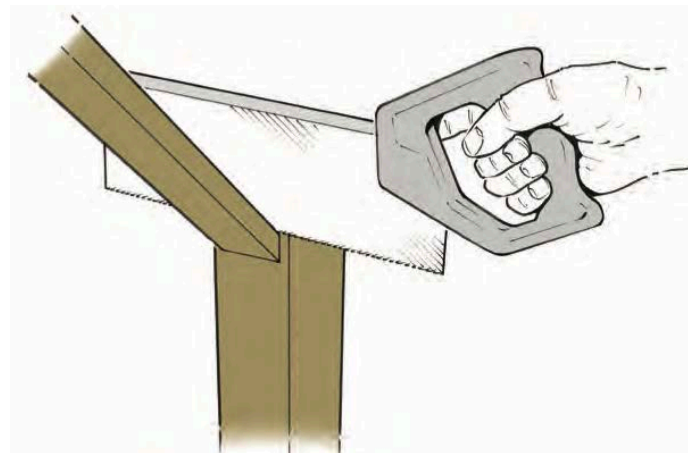

5. SETTING HANDRAIL HEIGHT

SEE COMPONENTS SHEET FOR POSITION OF HANDRAIL BRACKETS:

Bottom of BOTTOM bracket height from top of baserail

Bottom of TOP bracket height from top of baserail

Shown in mm

Applicable to both PIVOT (B type) and FLANGE (A/C types) brackets

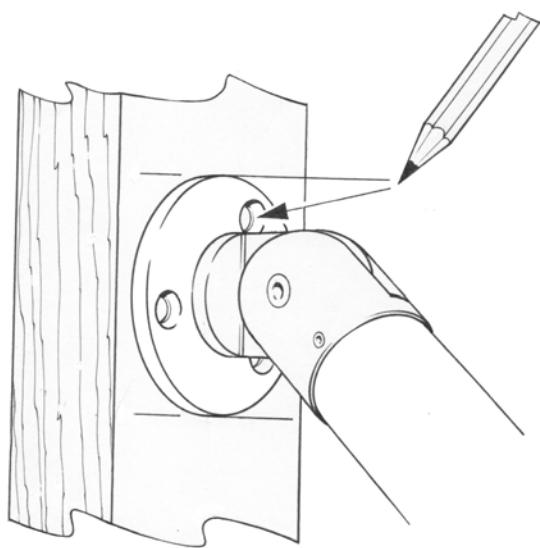

Pivot handrail bracket may vary to illustration - now with smaller flat edged back plate, with 4 fixings

Create a pencil line and centred on the newel post position the handrail pivot bracket (supplied).

Mark the centre of the holes, remove the handrail bracket and drill three pilot holes into the newel post. Fit the brackets with the rail inserted (screws supplied).

Fit the handrail bracket to the other newel post repeating the same process.

Tighten the grub screws to secure handrail (oak rail may need mastic adhesive).

6. FIXING THE GLASS PANELS

Two people recommended.

Glass orientation is indicated with height dimensions written with chalk pen on each panel.

Position the glass onto the bottom half glass clamp. A 25mm horizontal gap should be allowed between the newel post (or wall) and the edge of the piece of glass, as well as between each panel of glass. The spacer block provided is 25mm wide and can be used as a guidance tool to set this gap. With the other person holding the Glass fit the other half glass clamp. Do not over tighten at this stage to allow for movement of Glass.

Supporting the glass fit the top glass brackets in the same way. When the positions of the glass panels are correct tighten all the bolts in the glass brackets.

